

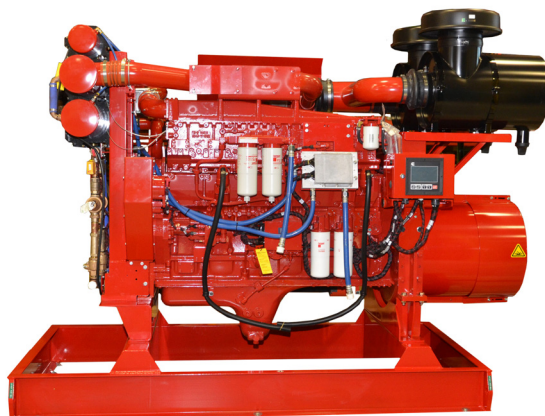

Specification sheet

Fire pump drive engine

CFP23E-F40



Description

Engine series - Cummins QSK23 Series

Exhaust emissions - EPA Tier 2

The CFP23E engine G-Drive ratings provide higher torque values. It has advanced electronics which are capable of smooth operation, higher torque, and better speed control.

Features

Certified power - The CFP23E-F40 complies with NFPA 20 and is UL 1247 Listed and FM 1333 Approved.

Control system - The industry-leading, state-of-the-art Fire Pump Digital Panel (FPDP) provides total fire pump drive engine system integration and intuitive operation, including:

- Color touchscreen;
- Dual microprocessors for critical signal redundancy;
- Standard J1939 parameter and Cummins fault code display;
- Engine idling;
- Electronic Control Module (ECM) self-diagnosis; and
- Optional Modbus field server remote messaging capability.

Warranty and service - Our models are backed by a comprehensive warranty and worldwide distributor network.

Operating speed (RPM)	Ratings in HP (kW)			
	1470		1760	
CFP23E-F40 NFPA, UL & FM	747	(557)	850	(634)

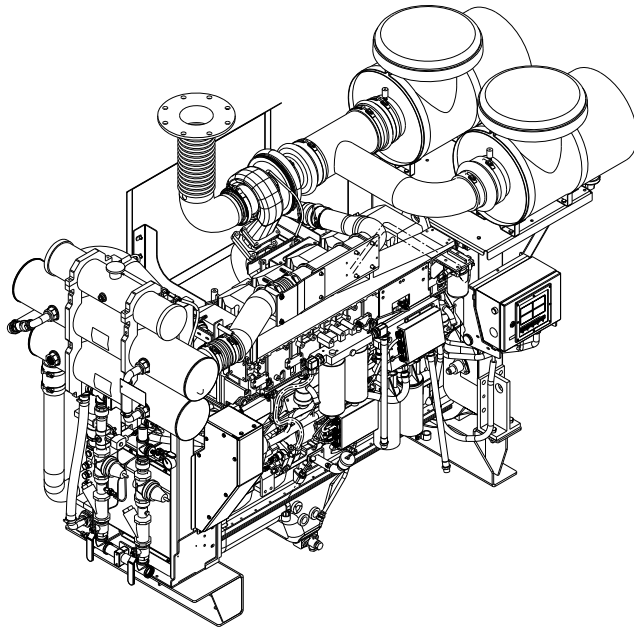

General engine data

Engine type	4 Cycle; In-Line, 6 Cylinder
Aspiration	Turbocharged and After-cooled
Bore and stroke	6.69 x 6.69 in. (170 x 170 mm)
Displacement	1413 in ³ (23.2 L)
Rotation	Counterclockwise from flywheel end
Compression ratio	16.0:1
Valves per cylinder	Intake - 2 Exhaust - 2
Fuel system	High-pressure Injection (HPI)
Maximum allowable bending moment @ rear face of block	2360 lb.-ft. (3205 N-m)
Estimated wet weight*	6805 lbs. (3087 kg)

* Weight includes engine, cooling loop, heat exchanger, dual Electronic Control Modules (ECMs), Fire Pump Digital Panel (FPDP), standard air cleaner, standard exhaust flex, and all fluids.

Equipment	Standard	Optional
Air cleaner	Heavy-duty, two-stage with replaceable elements	N/A
Alternator	24V-DC, 35 amps; includes belt guard	N/A
Cooling loop (maximum pressure of 300 PSI)	1 1/4" diameter for fresh water; includes alarm sensors and FM-approval	Cu Ni construction available for sea water applications
Cooling system	Sea water tube and shell type, 60 PSI with NPTF connections	Radiator ¹
Engine heater	240V-AC, 4000 watts	480V-AC, 4000 watts
Exhaust protection	Metal guards on manifolds and turbocharger	N/A
Exhaust flex connection	Steel, flanged	Stainless steel flex, NPT
Flywheel power take-off	Flywheel	Driveshaft system, stub shaft
Fuel connections	Fire-resistant flexible supply and return lines	N/A
Fuel filter	Spin-on primary and secondary	N/A
Governor, speed	Constant speed, electronic	N/A
Fire pump digital panel (FPDP)	7" color touchscreen; enclosure rated as Type 2/Type 4X; Imperial and metric values	Optional 316SS construction; custom gauges with digital panel expansion module (DPEM)
Lube oil cooler	Engine-water-cooled, plate type	N/A
Lube oil filter	Full-flow with by-pass valve	N/A
Lube oil pump	Gear-driven	N/A
Manual start controls	On FPDP and/or contactors	N/A
Overspeed controls	Electronic with reset and test on FPDP	N/A
Starter	24V-DC	24V-DC/pneumatic ² /hydraulic ²

¹ Not UL Listed and not FM Approved.

² Only approved as a secondary starter.

Air induction system

Maximum temperature rise between ambient air and engine air inlet	63 °F (35 °C)
Maximum inlet restriction with dirty filter	25 in. H ₂ O (635 mm H ₂ O)
Recommended air cleaner element - (standard)	(1) primary element AF25544; (1) secondary element AF25545

Lubrication system

Oil pressure range at rated	50-65 PSI (345-448 kPa)
Oil capacity of pan (high - low)	60-48 qt. (57-45 L)
Total system capacity	16.1 gal. (61 L)
Recommended lube oil filter	(2) Cummins Filtration LF9325

Cooling system*

Raw water working pressure range at heat exchanger	60 PSI (413 kPa) MAX
Recommended minimum water supply pipe size to heat exchanger	1.25 in. (31.75 mm)
Recommended minimum water discharge pipe size from heat exchanger	1.50 in. (38.10 mm)
Coolant water capacity (engine only)	17.3 gal. (65.5 L)
Standard thermostat - type	Modulating
Standard thermostat - range	170-194 °F (76.5-90 °C)
Normal Operating Temperature	180-212 °F (82-100 °C)
Minimum raw water flow:	
- with water temperatures to 60 °F (16 °C)	28 GPM (1.77 L/sec)
- with water temperatures to 80 °F (27 °C)	33 GPM (2.08 L/sec)
- with water temperatures to 100 °F (38 °C)	38 GPM (2.40 L/sec)
Recommended cooling water filter	(1) Cummins Filtration WF2076

* A jacket water heater is mandatory on this engine. The recommended heater wattage is 3000 down to 40 °F (4 °C)

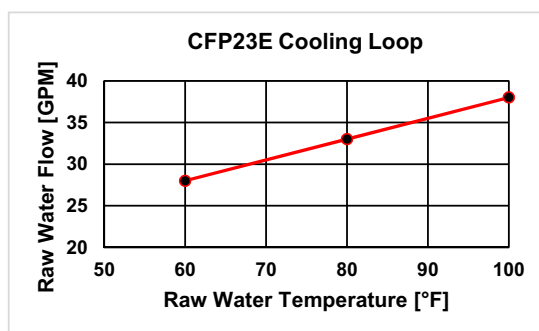

Exhaust system

Maximum allowable back pressure by complete exhaust system	40.8 in. H ₂ O (10.2 kPa)
Exhaust pipe size normally acceptable	8 in. (203 mm)

Noise emissions - The noise emission values are estimated sound pressure levels at 3.3 ft. (1 m).

Top	104.4 dBa
Right side	105.0 dBa
Left side	105.0 dBa
Front	103.0 dBa
Exhaust	121.0 dBa

Fuel supply/drain system

Operating speed in RPM	1470		1760	
Fuel rate - gal/hr (L/hr)	34.0	(128.6)	39.7	(150.5)

Fuel type	No. 2 diesel only
Minimum supply line size	1 in. (25.40 mm)
Minimum drain line size	1 in. (25.40 mm)
Maximum fuel line length between supply tank and fuel pump	40 ft. (12 m)
Maximum fuel height above C/L fuel pump	96 in. (2.4 m)
Recommended fuel filter - primary	(2) Cummins Filtration FS1006
Recommended fuel filter - secondary	None
Maximum restriction @ lift pump-inlet - with clean filter	4.0 in. Hg (102 mm Hg)
Maximum restriction @ lift pump-inlet - with dirty filter	8.0 in. Hg (203 mm Hg)
Maximum return line restriction - with check valves	9 in. Hg (229 mm Hg)
Minimum fuel tank vent capability	100 ft ³ /hr (3 m ³ /hr)
Maximum fuel temperature @ lift pump inlet	158 °F (70 °C)

Starting and electrical system

Minimum recommended battery capacity - cold soak at 0 °F (-18 °C) or above	24V
Engine only - cold cranking amperes	1400 CCA*
Engine only - reserve capacity	460 minutes*
*Based on FM requirement for a minimum of 900 CCA and 430 reserve capacity minutes	
Battery cable size - minimum of 2/0 AWG and maximum cable length not to exceed 6 ft. (1.5 m)	24V
Maximum resistance of starting circuit	0.002 Ohms
Typical cranking speed	100 RPM
Alternator (standard), internally regulated	35 amps

Operating conditions

Operating speed in RPM	1470		1760	
	Output - BHP (kW)	747	(557)	850
Ventilation air required - CFM (litre/sec)	1327	(626)	1705	(805)
Exhaust gas flow - CFM (litre/sec)	3692	(1743)	4026	(1900)
Exhaust gas temperature - °F (°C)	990	(532)	990	(532)
Heat rejection to coolant - BTU/min. (kW)	9451	(166)	10864	(191)
Heat rejection to ambient - BTU/min. (kW)	2840	(50)	3691	(65)

Engine performance for CFP23E-F40

RPM	lb-ft	N-m
1470	2669	3619
1760	2536	3439

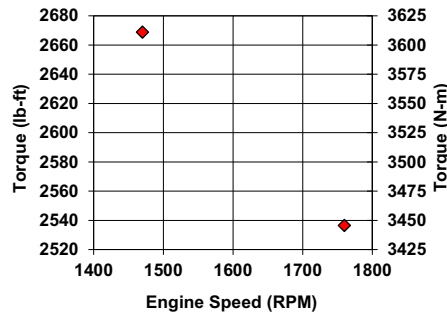

RPM	BHP	kW
1470	747	557
1760	850	634

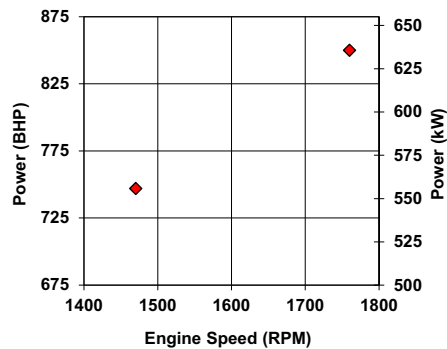

All data is based on the engine operating with a fuel system, water pump, lubricating oil pump, air cleaner, and alternator. The fan, optional equipment, and driven components are not included. Data is based on operation at SAE standard J1349 conditions of 300 ft. (91.4 m) altitude, 29.61 in. (752 mm) Hg dry barometer, and 77 °F (25 °C) intake air temperature, using No.2 diesel fuel only.

Altitude above which output should be limited*: 300 ft. (91.4 m)
 Correction factor per 1000 ft. (305 m) above altitude limit: 3%
 Temperature above which output should be limited: 77 °F (25 °C)
 Correction factor per 10 °F (11 °C) above temperature limit: 1% (2%)
 * Above 5,000 feet, contact Cummins for derate information.

US EPA NSPS Tier 2 Emissions Compliance

Fuel Percentage of Sulfur	D2 Cycle Exhaust Emissions*									
	Grams per BHP - HR					Grams per kW - HR				
	NMHC	NO _x	NMHC + NO _x	CO	PM	NMHC	NO _x	NMHC + NO _x	CO	PM
15 PPM Diesel Fuel	0.271	3.747	4.018	0.373	0.085	0.363	5.025	5.388	0.500	0.114
300-4000 PPM Diesel Fuel	0.328	4.064	4.392	0.373	0.097	0.440	5.450	5.890	0.500	0.130

*The emissions values above are based on CARB approved calculations for converting EPA (500 ppm) fuel to CARB (15 ppm) fuel.

Refer to the engine data tag for the EPA Standard Engine Family.

No special options are needed to meet current regulation emissions for all fifty states.

Tests conducted using alternate test methods, instrumentation, fuel, or reference conditions can yield different results.

Diesel Fuel Specifications:

- Cetane Number: 40-48
- Reference: ASTM D975 No. 2-D

Reference Conditions:

- Air Inlet Temperature: 25 °C (77 °F)
- Fuel Inlet Temperature: 40 °C (104 °F)
- Barometric Pressure: 100 kPa (29.53 in Hg)
- Humidity: 107 g H₂O/kg (75 grains H₂O/lb) of dry air; required for NO_x correction
- Intake Restriction set to a maximum allowable limit for clean filter
- Exhaust Back Pressure set to maximum allowable limit

Fire pump digital panel (FPDP)



The Cummins FPDP is an integrated microprocessor-based control system that provides full digital technology with enhanced accuracy and built-in redundancy.

Reliable design - Designed and tested with isolated mounting to minimize vibration for longer life and durability, the Cummins FPDP proves reliable in harsh environments.

Advanced control methodology - The Cummins FPDP allows for Input/Output (I/O) expansion and remote monitoring capabilities, as well as automatic Electronic Control Module (ECM) switching for electronic engines.

Certified quality - The Cummins FPDP is UL 1247 Listed and FM 1333 Approved.

Operator panel features

Operator/display panel

- 7" TFT LCD (thin-film-transistor liquid-crystal display) - color, 24-bit, 800x480 (WVGA).
- Auto, manual, start, stop, and fault reset.
- Assembly enclosure that meets NEMA Type 2 and Type 4X design requirements and is water, corrosion, fire, and impact-resistant.

Electronic engine communications - SAE J1939 protocol.

- Comprehensive full-authority engine (FAE) data: oil pressure and temperature; coolant temperature; and intake manifold pressure and temperature.
- Cummins fault code display.
- Sensor failure indication.
- Optional RS-485 serial - Modbus RTU/Modbus TCP/IP.

Other control features

- Digital Panel Expansion Module (DPEM) for additional analog/digital inputs and configurable dry relay contact output.
- Ability to idle at start-up for commissioning of electronic engines.
- Idle cool down for electronic engines.

Functional

- Configurable display units for temperature in degrees Fahrenheit or Celsius and pressure in PSI or kPa.
- Manual ECM selector switch on electronic engines.
- Ability to crank the fire pump drive engine from Battery A, Battery B, or both.
- Fixed engine speed adjustments in +/- 10 RPM increments.
- Overspeed shutdown.

Environmental

- Operating temperature: minus 4 to 140 °F (minus 20 to 60 °C).
- Storage temperature: minus 22 to 176 °F (minus 30 to 80 °C).
- Meets CISPR 11 Class B radiated emissions.

Electrical

- 8-30 VDC operating voltage.
- Reverse polarity protected.
- Spring cage terminal block interface.
- Built-in dual micro controllers for increased reliability.

Mechanical

- 1 3/8" pre-cut customer conduit knockout for easy field installation.
- Simplified internal design for efficiency and ease of customer connections.
- 16GA ASTM A366 material - 316 stainless steel optional.
- RAL3001 red powder coat finish.

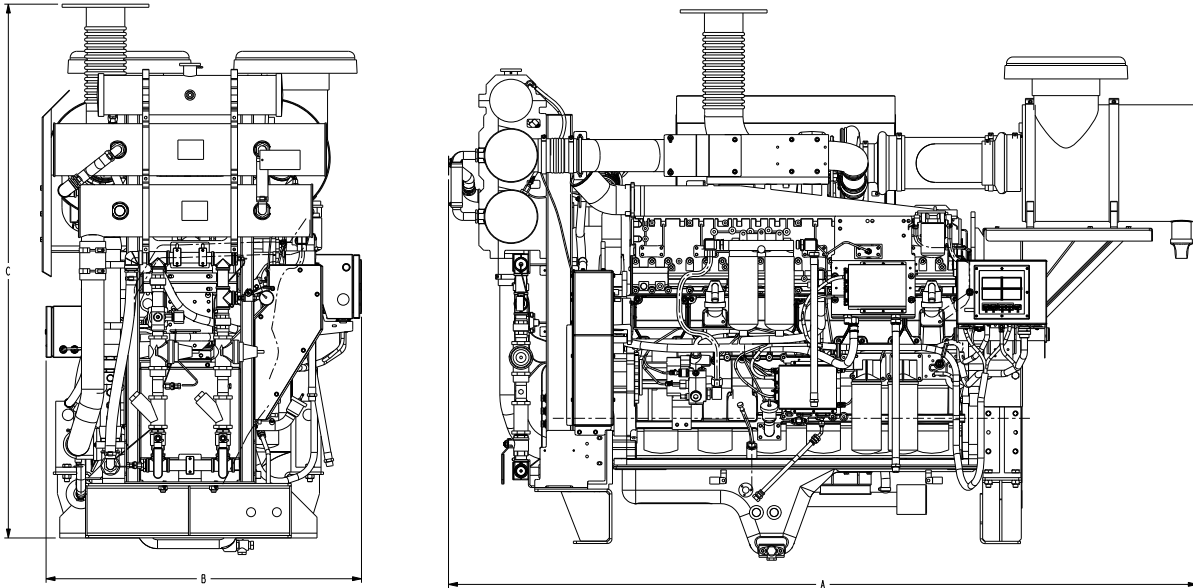

This outline drawing is for reference only.
Do not use for installation design.

	Dim "A" in. (mm)	Dim "B" in. (mm)	Dim "C" in. (mm)
CFP23E	117 (2972)	50 (1270)	86 (2184)

NOTE: Consult drawings or contact the factory for additional information.

NOTE: Specifications are subject to change without notice.
For more information, contact firepumpsales@cummins.com.



This product has been manufactured under the controls established by a Bureau Veritas Certification approved management system that conforms with ISO 9001:2015.



Cummins Inc.
Box 3005
Columbus, IN 47202-3005
U.S.A.

1-800-CUMMINS™ (1-800-286-6467)
cummins.com

Printed in U.S.A.
©2021 Cummins Inc.